

AMP RESEARCH Power Step

MADE IN USA

APPLICATION

AMP Part #

Override Switch

79106-01A

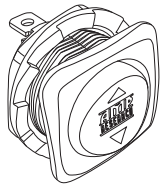

1
Override Switch

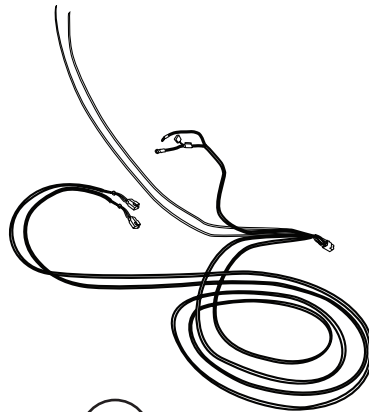

2
Harness

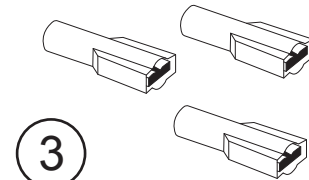

3
Connectors

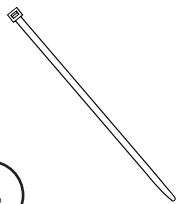

4
Cable Ties (x10)



5
Grommet

TOOLS REQUIRED

- cordless drill
- 3/4", 9/32" & 1/8" drill
- Wire crimpers
- Wire stripper/cutter

WARRANTY

5-Year Limited Warranty

AMP RESEARCH TECH SUPPORT 1-888-983-2204 (Press 2) Monday - Friday, 7:00 AM - 5:00 PM PST

Invented, engineered and manufactured exclusively by AMP Research in the USA. May be covered by one OR MORE of the following patents: 6,641,158; 6,830,257; 6,834,875; 6,938,909; 7,055,839; 7,380,807; 7,413,204; 7,398,985; 7,584,975; 7,566,064; 7,487,986; 8,157,277; 8,408,571; 9,302,626; 9,561,751; 10,053,017; CA2463717 ©2012 AMP Research. All rights reserved. Printed in USA.

AMP RESEARCH POWERSTEP™ – OVERRIDE SWITCH

Locate White 8 pin connector and unplug from controller. Remove Pin plugs from location 5,6,&7. Insert Green wire into pin 7, White wire into pin 5, Black wire into pin 6. Once pin is engaged pull lightly on wire to verify engagement.

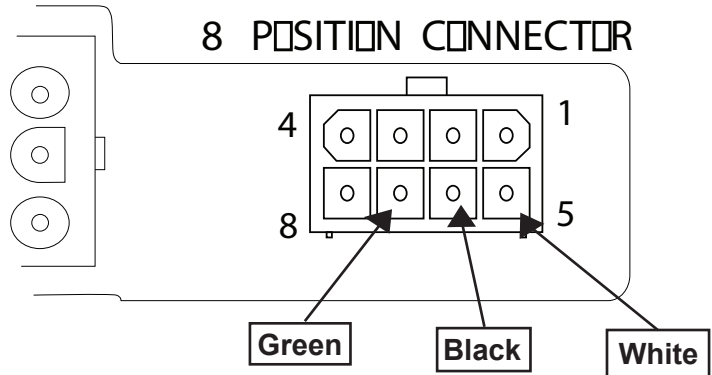
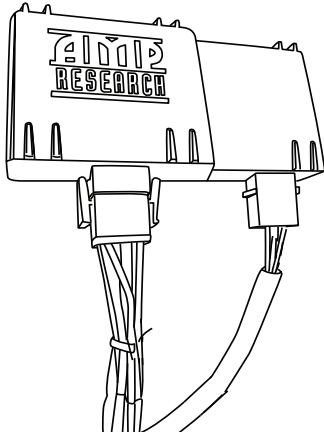

1

Route harness in the cab of vehicle. A grommet is provided if needed, use 9/32 drill for grommet.

Depending on vehicle configuration select desired switch location on dash. Before drilling hole check behind dash panels for obstructions.

Note: Wires may be present behind dash panels.

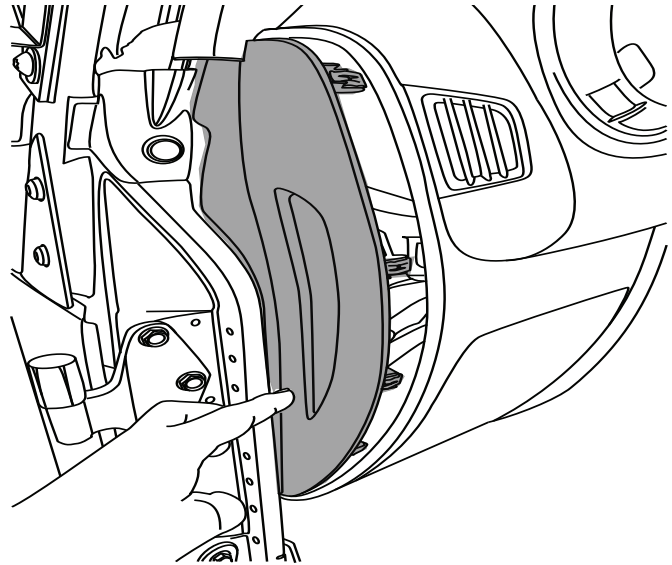

2

Once switch position is selected, mark and drill out mounting hole. Pre drill using 1/8" drill bit. Final drill size will be 3/4". **We recommend using a step drill!**

Once Hole is drilled and switch wires are pulled into vehicle crimp supplied connectors onto the 3 wires.

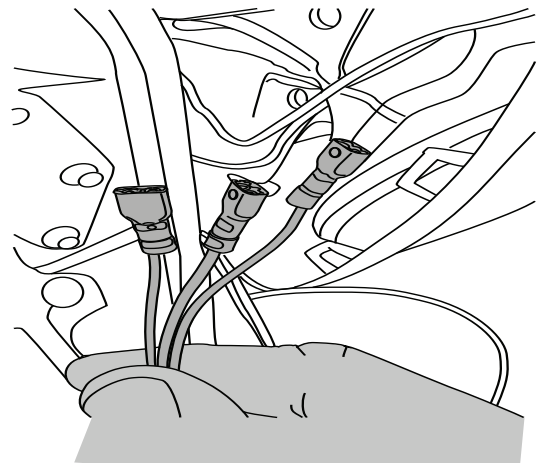
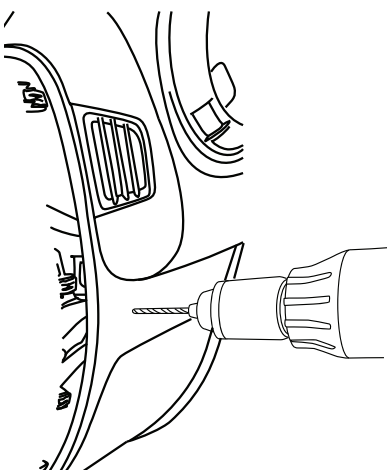

3

4

AMP RESEARCH POWERSTEP™ – OVERRIDE SWITCH

Mount switch in drilled hole and tighten nut on switch. Slide terminals with wire colors shown below

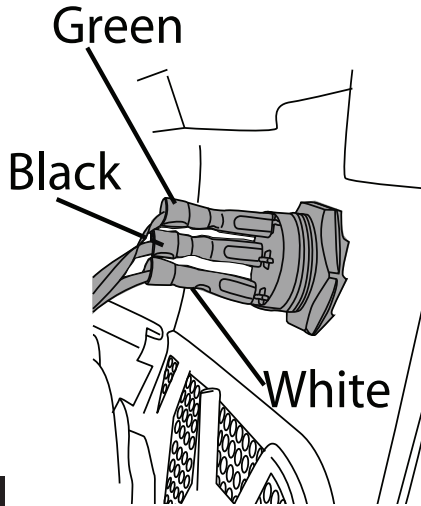

5

Reinstall all trim panels that were removed to install switch onto dash.

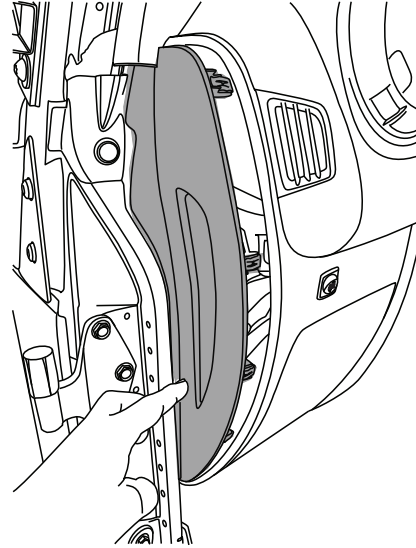

6

Installation complete. Verify switch operates properly.

Toggle Up: Running Boards Retract and remain in the Stowed Position

Neutral / Auto: Running Boards in Auto position operate with doors opened and closed.

Toggle Down: Running Boards Deploy and remain in Deployed Position

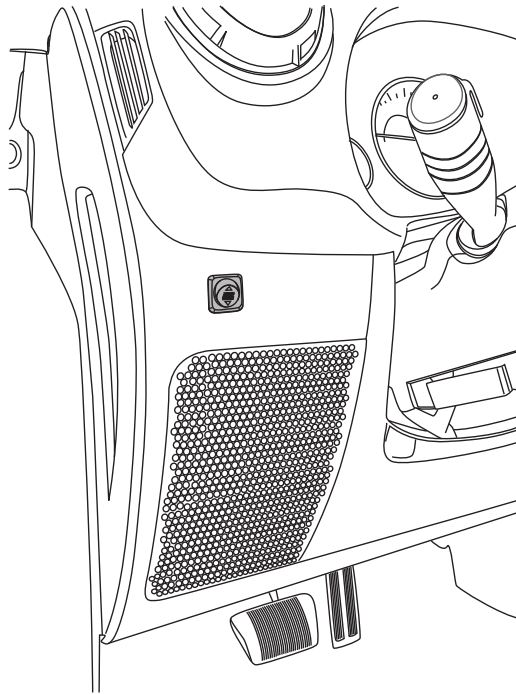

Note: Running Boards will return to Auto Operation in the next door cycle after 30 minutes.

7



AMERICAN DESIGNED, ENGINEERED AND MANUFACTURED.

Thank you for your recent AMP Research Purchase.

**REGISTER YOUR PRODUCT TODAY FOR
FASTER SERVICE & PRODUCT UPDATES**

Please visit:

www.amp-research.com/productregistration
or scan the QR Code



Product Registration Benefits:

- Ensure we have your purchase receipt and product info in our system which is required for warranty
- Faster and easier access to customer service and tech support in the unlikely event you need warranty or product support
- Registration helps us keep you up to date on product information and offers

To view other Amp Research products that may be offered for your vehicle.

Please visit: www.amp-research.com

POWER-DEPLOYABLE RUNNING BOARDS OPERATION: AMP Research PowerStep running boards automatically move when the doors are opened to assist entering and exiting the vehicle.

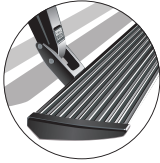

Automatic power deploy:

The running boards will extend down and out when the doors are opened.

Automatic power stow:

The running boards will return to the stowed position when the doors are closed. There will be a 2-second delay before the running boards move to the stowed position.

Automatic stop:

If an object is in the way of the moving running board, the running board will automatically stop. To reset, clear any obstruction, then simply open and close the door to resume normal operation.



Manually set in the deployed (OUT) position for access to the roof:

The running boards can be manually set in the deployed position by firmly holding the step down with your foot while at the same time closing the door. To resume normal operation, open and close the door.

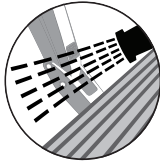

Maintenance: In adverse conditions, debris such as mud, dirt, and salt may become trapped in the running board mechanism, possibly leading to unwanted noise. If this occurs, manually set the running boards to the deployed position and flush the front and rear hinge arms with a high-pressure car wash wand.

Avoid spraying the motors directly. After washing, apply silicone spray lubricant to the hinge pivot pins. Do not apply silicone, wax or protectants like Armor All® to the running board stepping surface.

Caution! Keep hands away when the running board is in motion.

5-YEAR LIMITED WARRANTY

AMP RESEARCH warrants this product to be free from defects in material and workmanship for FIVE (5) YEARS FROM DATE OF PURCHASE, provided there has been normal use and proper maintenance. This warranty applies to the original purchaser only. All remedies under this warranty are limited to the repair replacement of the product itself, or the repair or replacement of any component part thereof, found by the factory to be defective within the time period specified. The decision to repair or replace is wholly within the discretion of the manufacturer.

This warranty specifically excludes labor. If you have a warranty claim, first you must call our factory at the number below for instructions. You must retain proof of purchase and submit a copy with any items returned for warranty work. Upon completion of warranty work, if any, we will return the repaired or replaced item or items to you freight prepaid. Damage to our products caused by accidents, fire, vandalism, negligence, misinstallation, misuse, Acts of God, or by defective parts not manufactured by us, is not covered under this warranty.

ANY IMPLIED WARRANTIES OF MERCHANTABILITY AND/OR FITNESS FOR A PARTICULAR PURPOSE CREATED HEREBY ARE LIMITED IN DURATION TO THE SAME DURATION AND SCOPE AS THE EXPRESS WRITTEN WARRANTY. OUR COMPANY SHALL NOT BE LIABLE FOR ANY INCIDENTAL OR CONSEQUENTIAL DAMAGE.

Some states do not allow limitations on how long an implied warranty lasts, or the exclusion or limitation of incidental or consequential damages, so the above limitations or exclusions may not apply to you. This warranty gives you specific legal rights, and you may also have other rights that vary from state to state.

FOR WARRANTY ISSUES WITH THIS PRODUCT PLEASE CALL AMP RESEARCH CUSTOMER SERVICE 1-888-983-2204

WARNING

Be sure to read and precisely follow the provided instructions when installing this product. Failure to do so could place the vehicle occupants in a potentially dangerous situation. After installing or reinstalling, re-check to insure that the product is properly installed.



The material that your product is made from can be recycled. Please also consider recycling the packaging that your product came in.

